

► ABI Add-on auger drives

The **auger drive BA** or the **auger drive DBA** with passage can be operated on common hydraulic excavators. Together with casing twister cased boreholes installation is possible.

For the production of CFA piles a swivel for concreting must be mounted to the auger drive, so that immediate concreting is possible during the pulling procedure. The auger drive can be applied for ground release drilling, ground investigation, soldier pile installation, displacement augering, CFA piles, injection and soil improvement for foundations.

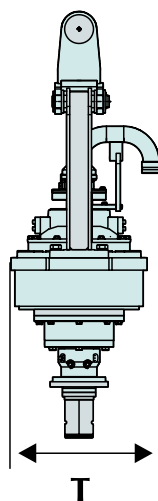
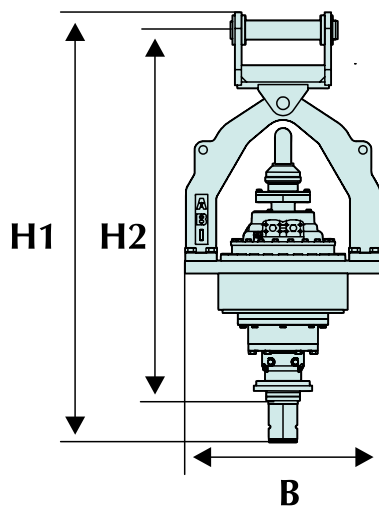

■ DBA 2200

Technical data	Unit	DBA 2200
Torque	daNm	2200
Revolutions	min ⁻¹	70
Static extraction force max.	kN	200
Hydraulic flow rate	l/min	300
Required oil quantity per rotation	l/min	4,4
Required hydr. power at auger drive	kW	160
Nominal oil pressure	MPa	32
Total weight / transport weight	kg	900 / 1000
Hexagon connection	mm	120
Concrete swivel Inner diameter Ø		DN 65

Dimension	Unit	DBA 3200
H1 Height	mm	2075
H2 Locking to bottom	mm	1790
B Width	mm	945
T Depth	mm	730
Transport dimension H / B T	mm	2600 / 1250 850